

# GalvinAssist<sup>®</sup> PWD Back Rest

## PRODUCT CODE:

- 105.76.02.01

### SPECIFICATIONS

- The GalvinAssist<sup>®</sup> PWD Back is a WC support device for disabled, aged and the infirmed. Complies with clause 15.2.4 of AS 1428.1-2009 if positioned correctly according to the standard.

### TECHNICAL DATA

<b>Features:</b>	Suits single PWD cubicle with either conventional or wall faced pans Suits combined PWD compartment featuring WC and shower recess grab rail
<b>Fixings:</b>	Rails are supplied with stainless steel fixing screws
<b>Finish:</b>	Satin Stainless Steel Polar White UV stabilised HDPE rounded edge back support

**NOTE:** Galvin Specialised continually strive to improve their products. Specifications may change without notice.

### DIMENSIONS

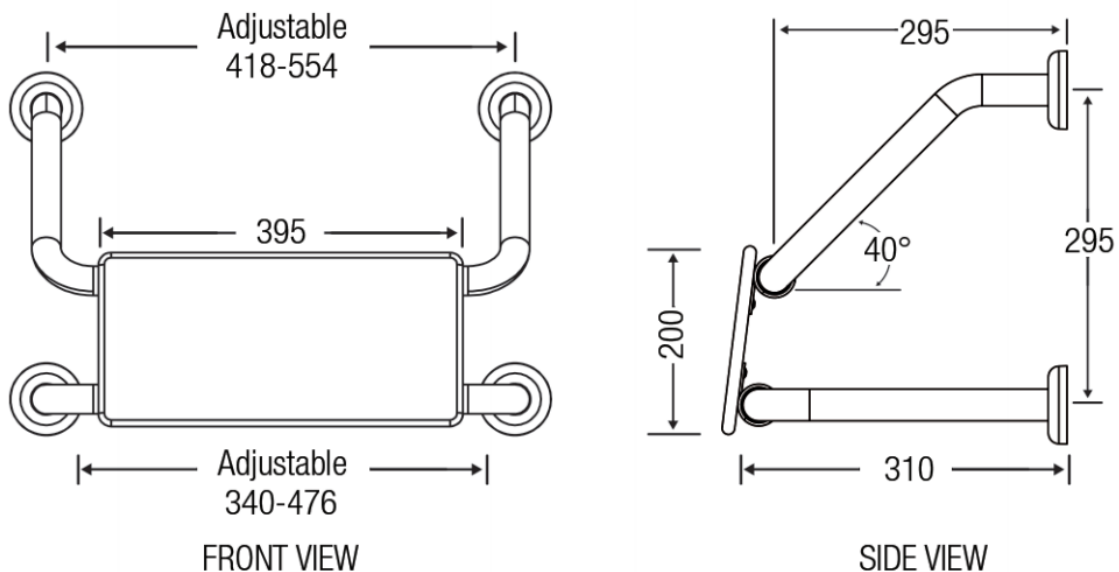

**ASSEMBLY**

**Start with marking wall**

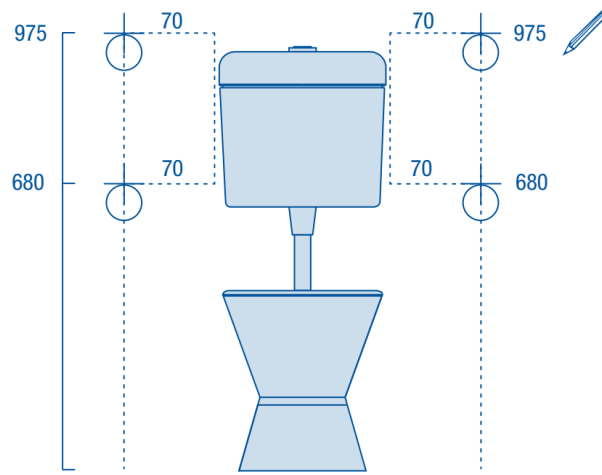

**Top Fixing** – Mark wall 975 mm from floor and 70 mm either side of cistern.

**Bottom Fixing** – Mark wall 680 mm from floor and 70 mm either side of cistern.

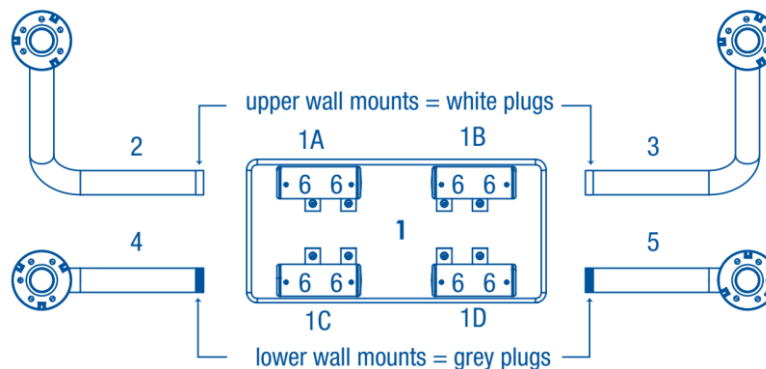

**NOTE:** Loosen Grub screws (6) Before Commencing installation.

1. Pre-assemble backrest (1).
2. Insert upper wall mounts with white plugs (2 & 3) into support tubes (1A & 1B).
3. Adjust the distance between wall mount flanges to 76mm less than the measurement between vertical wall marks and gently tighten grub screws.
4. Place top centre of the upper wall mount flanges (2 & 3) on the top fixing mark and mark preferred fixing holes.
5. Fix upper mount tubes loosely to the wall (see Mounting Details section).
6. Insert lower wall mounts with grey plugs (4 & 5) into support tubes (1C & 1D) and repeat from step 4 with lower wall mounts.
7. Tighten all wall fixings.
8. Centre backrest (1) to toilet and tighten grub screws (6).

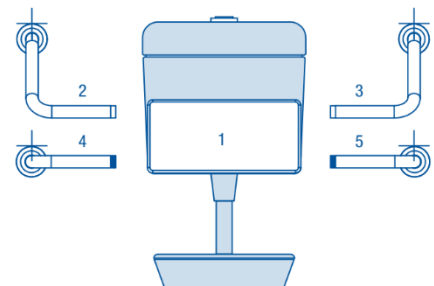



## Product Installation Guideline

Version 1, 23 June 2020, Page 3 of 4

### MOUNTING TO TIMBER

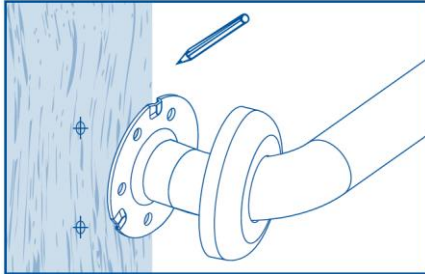

Place back rest on wall in line with studs and mark location of screw holes.

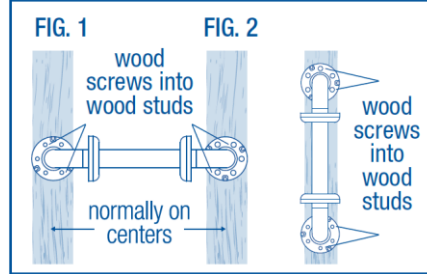
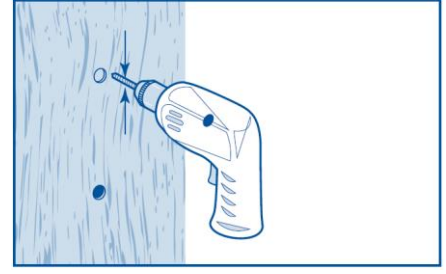
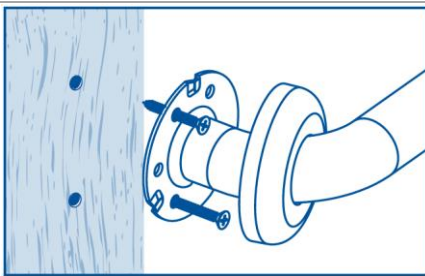

Fig. 1 – Horizontal attachment.  
Fig. 2 – Vertical attachment.



After marking, drill small hole to confirm location of stud.



Use 50mm x14g self-tapping stainless steel screws supplied.

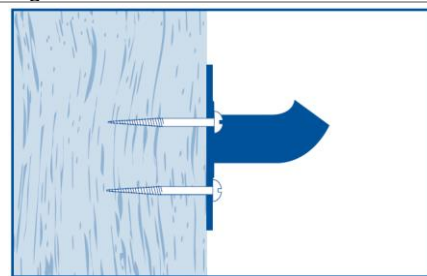

Ensure screws are fully engaged within substrate.

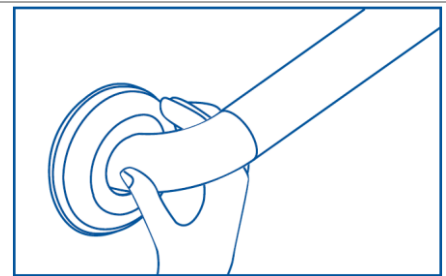

Press flange covers over the wall flanges.

### MOUNTING TO MASORY

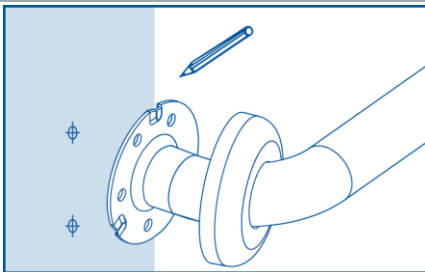

Place back rest on wall and mark location of screw holes.

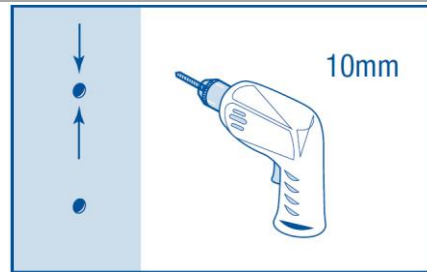

Drill 10mm holes.

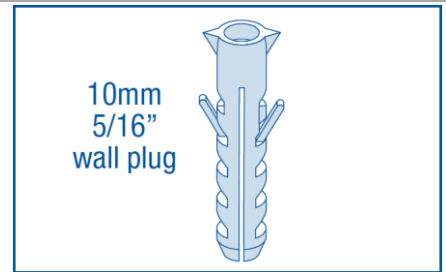

Use wall plugs supplied.

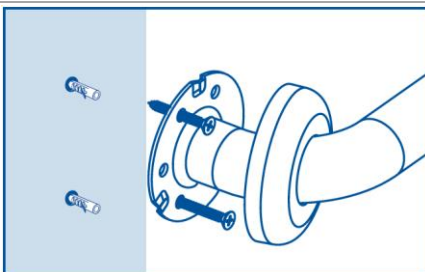

Use 50mm x 14g self-tapping stainless steel screws supplied.

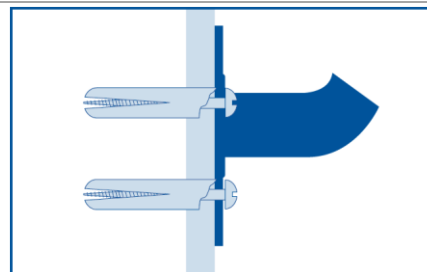

Ensure screws are fully engaged within substrate.

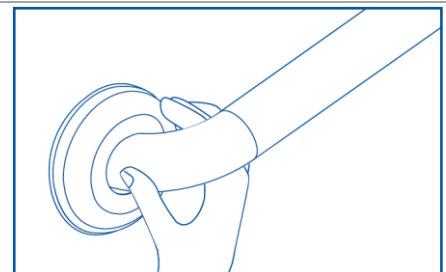

Press flange covers over the wall flanges.



## WARRANTY

The warranty set forth herein is given expressly and is the only warranty given by the Galvin Engineering Pty Ltd. With respect to the product, Galvin Engineering Pty Ltd makes no other warranties, express or implied. Galvin Engineering Pty. Ltd. hereby specifically disclaims all other warranties, express or implied, including but not limited to the implied warranties of merchantability and fitness for a particular purpose.

Galvin Engineering Pty Ltd products are covered under our manufacturer's warranty available for download from [www.galvinengineering.com.au](http://www.galvinengineering.com.au) Galvin Engineering Pty Ltd expressly warrants that the product is free from operational defects in workmanship and materials for the warranty period as shown on the schedule in the manufacturer's warranty. During the warranty period, Galvin Engineering will replace or repair any defective products manufactured by Galvin Engineering without charge, so long as the terms of the Manufacturer's warranty are complied with.

The remedy described in the first paragraph of this warranty shall constitute the sole and exclusive remedy for breach of warranty, and Galvin Engineering Pty Ltd shall not be responsible for any incidental, special or consequential damages, including without limitation, lost profits or the cost of repairing or replacing other property which is damaged if this product does not work properly, other costs resulting from labour charges, delays, vandalism, negligence, fouling caused by foreign material, damage from adverse water conditions, chemical, electrical or any other circumstances over which Galvin Engineering has no control. This warranty shall be invalidated by any abuse, misuse, misapplication, improper installation or improper maintenance or alteration of the product.

